

Order form**TNS Activator 2022**

Dealer:

Advisor:

Client:

Adres:

Phone:

Framenumber:

Order date:

Date of fitting:

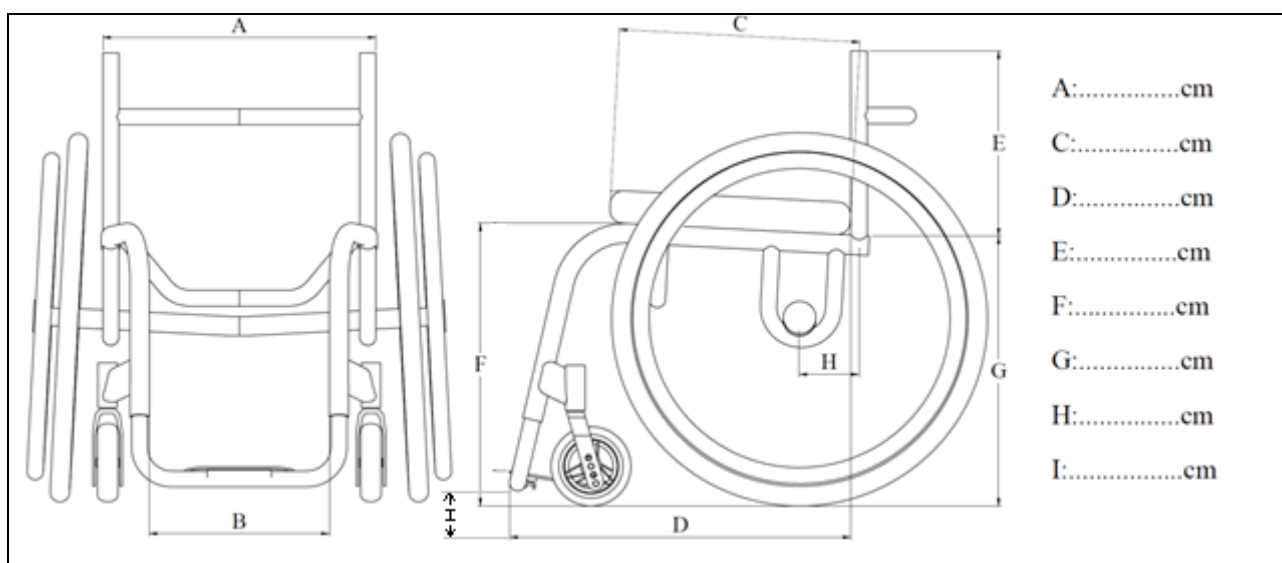

- Activator C. ADL (minimal frame as standard)
- Model 2.5 (also select boxframe)
- Growth set Activator G, from/to depth from/to (including adjustable C.O.G.)
- Activator C. Sport (boxframe advised)
- Model RX (also select boxframe)
- Basketball type CBB ACT2136 Hockey type CH ACT2137 Dancing type CD
- Tennis type CT ACT2138 Badminton type CB ACT2135 other type.....
- Boxframe (always select boxframe for model 2.5 and RX)

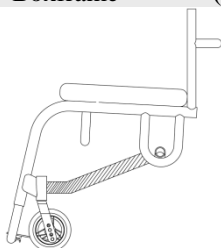

- Hinged front frame (type FC) (only possible with standard, straight or U-frame)
- Heavy Duty frame 100-125 kg
- A; Seat width (with removable sideguards effective seat width will be +1cm)

Tapered seatframe

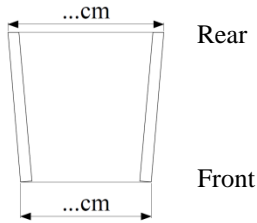

Partially tapered seatframe

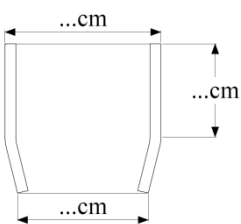

B; Std tapered front frame (U-frame). Space between front frame tubes is 9cm smaller than seat width

Custom tapered front frame (20cm space in between frame tubes at minimum)

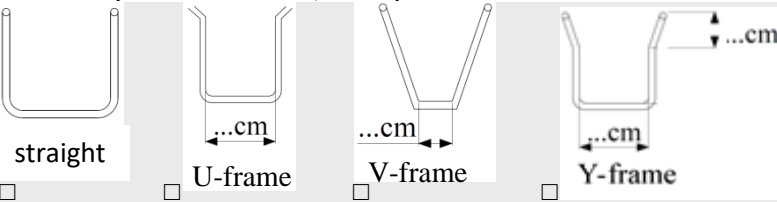

C; Seat depth

Ergonomic seat

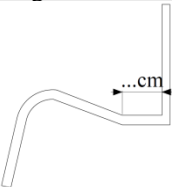

Frame extension from seat sling forward

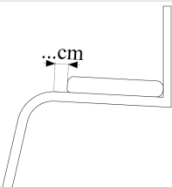

D; Frame length: front backrest to front footrest

E; Backrest height

- Backrest foldable/angle adjustable (select removable sideguards)
- Backrest welded
- Backrest-angle 90 degrees with the floor
- Backrest lockable
- Backrest lockable with pulling cord
 - Backrest <90 degrees (forward angle)
 - Backrest >90 degrees (backward angle)

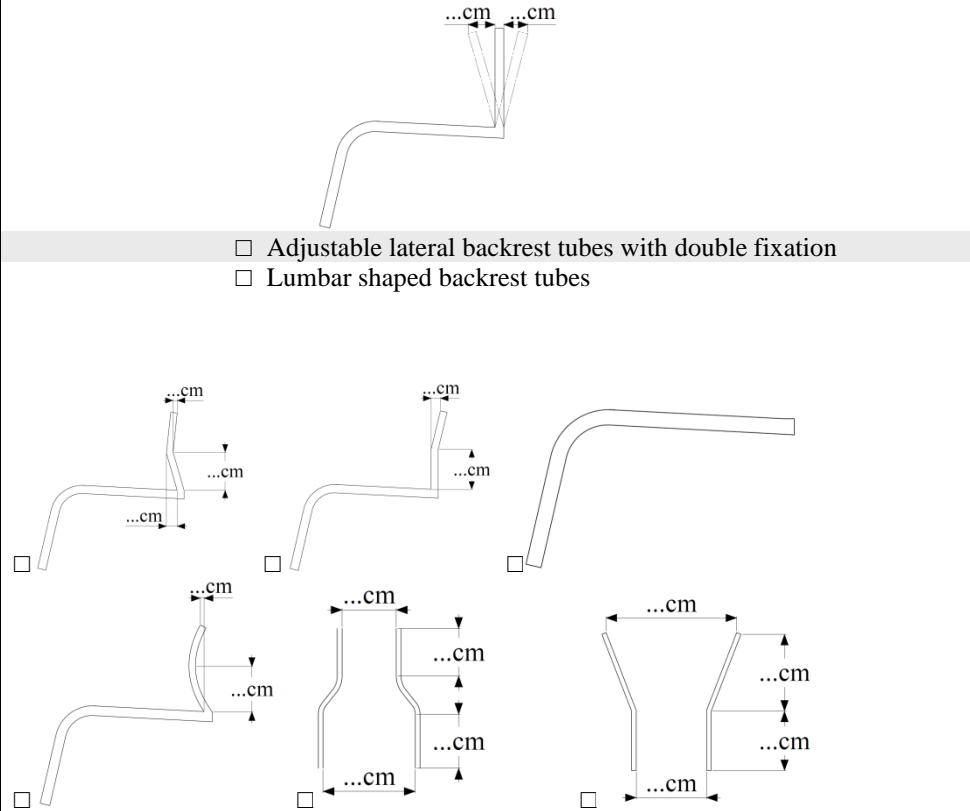

Adjustable lateral backrest tubes with double fixation
 Lumbar shaped backrest tubes

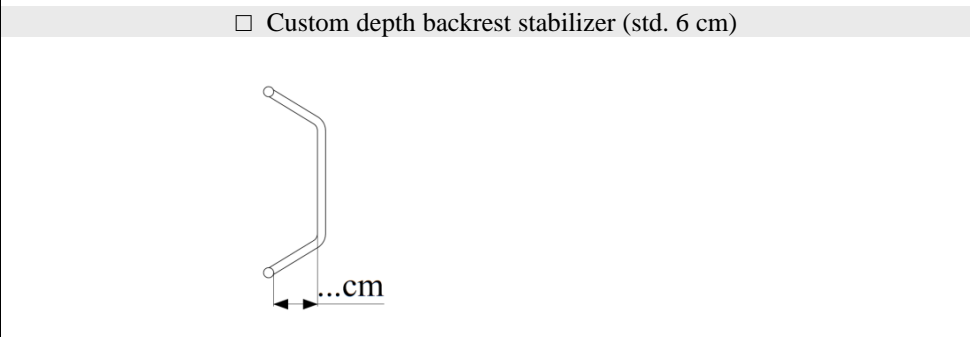

Custom depth backrest stabilizer (std. 6 cm)

Tension adjustable backrest upholstery (std.):
 Middle backrest upholstery in breathable fabric (black)
 Middle backrest upholstery in nylon:
 Red Blue Yellow Green White Black
 Fabric provided by customer
 Side backrest upholstery in nylon:
 Red Blue Yellow Green White Black
 Fabric provided by customer
 Tension adjustable backrest upholstery and cushion cover leather
 Backrest upholstery special (necessary with adjustable tapered backrest)
 Tension adjustable backrest upholstery in leather
 Side backrest fabric in leather

Seat depth adjustable (backrest on clamp block)

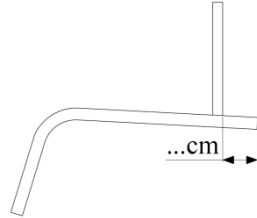

- F; Frame height front
- G; Frame height rear
- H; Centre of gravity (C.O.G.)
- Adjustable C.O.G. From ... cm to ... cm
- Second rear axle C.O.G.cm (middle backrest/middle axle (handbike axle))
- Camber ... degrees (0 - 20 degrees)

I; Space below footrest

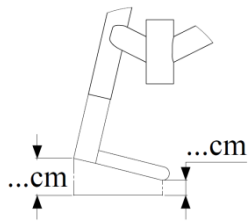

Total maximum width*
**as an indication (depending on seat-width, camber and wheelspace)*

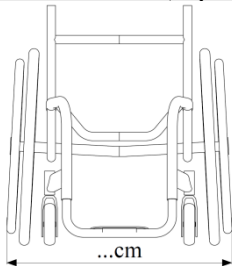

Wheelspace standard 2,5cm, orcm

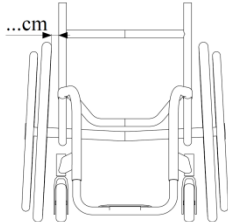

Length caster. front caster to front footrestcm



- Caster position forwards



- Urgent order, netto price (not always available)
- Aluminium seat plate welded on frame
- Scissor brakes (not available on all models)
- Scissor brakes on a sports wheelchair (not available on all models)
- Scissor brakes, compact
- Push/pull brakes
- Push/pull brakes on a sports wheelchair
- Push/pull brakes, single handed left / right operated
- Push/pull brakes, compact

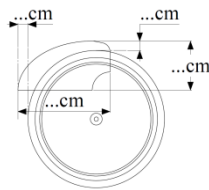
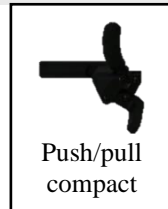
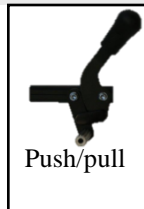
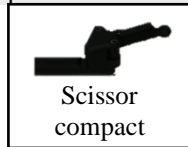

! Removable sideguards add +1cm in effective seat width !

- Aluminium removable sideguards with fender
- Aluminium removable sideguards, std. height (21cm)
- Aluminium removable sideguards, custom measurements
- Aluminium welded sideguards with fender
- Aluminium welded sideguards, custom measurements
- Carbon sideguards bolt on (only with welded backrest)
- Carbon sideguards with fender bolt on (only with welded backrest)
- Carbon sideguards, removable
- Carbon sideguards with fender, removable
- Rubber strip on sideguards
- Welded tube on sideguard (inside)
- Welded tube on sideguard (outside)
- Inside sideguard lined with foam, 1cm
- Inside sideguard lined with foam, 2cm
- Height adjustable/removable armrest (only with aluminium sideguards)
- Short (16cm) standard (26cm) long (36cm)
- Armrest padding straight (36cm)
- Armrest height adjustable type E.T., short
- Armrest height adjustable type E.T., long

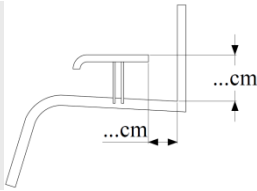

- Frame protectors, black
- Anti-tip, quick release, left
- Anti-tip, quick release stainless steel, left
- Anti-tip, quick release, right
- Anti-tip, quick release stainless steel, right
- Anti-tip, swing away left right
- Calf strap
- Feet strapping



- Feet strapping PVC
- Feet strapping (A2J) cm.
- Footplate ABS (only on footrest tube)
- Footplate aluminium (on footrest tube)
- Anti slip on footplate
- Stump support
- Stump support, mounted by mounting clamp
- Push handles foldable
- Height adjustable/removable push handles. Height from the floorcm
- Push handles on backrest stabilizer (combine with welded or lockable backrest)
- Heavy Duty Height adjustable/removable push handles. Height from the floorcm
- Cross bar between push handles
- Push handles bold on, model TNS
- Walking stick tray, stainless steel quick release mount
- Safety strapping (nylon and Velcro), cm
- Strapping (A2J) 2D small STR402 large
- Strapping (A2J) 3D small STR502 large
- Taxi fixation points, rear and front, welded (ISO 7176-19 compliant)
- Aluminium welded wear-plate on back axle
- Wheelchair tray custom size (please add drawing)
- Wheelchair tray mounting, welded in frame
- Frog Leg suspension front fork
- Mono-fork, 1.5" wide (only 4" or 5" wheels)
- One Arm Drive 24" / 25" / 26" left / light (not possible with HD frame)
- Custom One Arm Drive handrim (please add drawing)
- Preparation for electronic wheels (Alber/Decon) 12.7mm

- Hemiplegic dance handle, left. Height from the floorcm
- Hemiplegic dance handle, right. Height from the floorcm
- Anti-tip sportstyle, single, removable
- Anti-tip sportstyle, single, welded
- Anti-tip sportstyle, double, welded
- Defence bumper
- Full wing (not suited for Quad Rugby)
- Custom size footplate

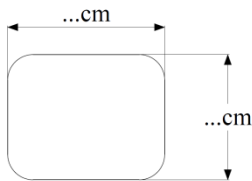

- Raised edges on footplate (please add drawing)

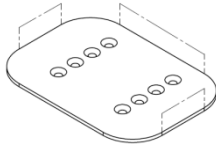

- Separate foldable footrests, including extra stabilizer
- Swing away footrest (one piece)
 - Left, including extra stabilizer
 - Right, including extra stabilizer
 - Backwards
- Extra front frame stabilizer
- I; Footrest, welded (footrest tube)
- I; Footrest, height and angle adjustable (aluminium plate 22x12cm)
- Standard swing away leg rest, 90 degrees, left
- Standard swing away leg rest, 90 degrees, right
- Standard swing away leg rest, 75 degrees, left
- Standard swing away leg rest, 75 degrees, right
- Leg rest socket welded in frame, left (leg rest not included)
- Leg rest socket welded in frame, right (leg rest not included)
- Comfort swing away leg rest, left. Including plastic calf plate
- Comfort swing away leg rest, left. Including cushioned calf plate
- Comfort swing away leg rest, right. Including plastic calf plate
- Comfort swing away leg rest, right. Including cushioned calf plate

- 3" LED wheels
- 3" Sport (hard)
- 3" Frogleg extra wide
- 4" LED wheels
- 4" Sport / daily (hard)
- 4" Soft rol
- 4" Star wheels
- 5" LED wheels
- 5" Daily (hard)
- 5" Soft rol
- 5" Star wheels
- 6" Poly
- 6" Frogleg extra wide
- Dust caps

- 20" Rear wheels
- 22" Rear wheels
- 24" Rear wheels
 - Black Silver Red Blue (matching forks)
- 24" Sports wheels
- 24" Spinergy LX, 12 spokes (black*)
- 24" Spinergy SLX, 24 spokes (black*)
- 24" Spinergy LX with Flexrim, 12 spokes (black*)
- 24" Spinergy SLX with Flexrim, 24 spokes (black*)
- 24" Off Road wheels, aluminium handrim, incl. ATB tires eff. 24"/25"/26"
- 25" Rear wheels
 - black Silver Red Blue (matching forks)
- 25" Sports wheels
- 25" X-Core wheels (3-spoke carbon)
- 25" Spinergy LX 12 spokes (black*)
- 25" Spinergy SLX 24 spokes (black*)
- 25" Spinergy LX with Flexrim, 12 spokes (black*)
- 25" Spinergy SLX with Flexrim, 24 spokes (black*)
- 26" Sports wheels
- 26" Spinergy LX, 12 spokes (black*)
- 26" Spinergy SLX, 24 spokes (black*)
- 26" Spinergy LX with Flexrim, 12 spokes (black*)
- 26" Spinergy SLX with Flexrim, 24 spokes (black*)
- 28" Sports wheels

- 24" Schwalbe Marathon Plus
- 24" Schwalbe Right Run
- 24" Schwalbe Camber tires, white
- 24" Solid tires
- 25" Schwalbe Marathon Plus
- 25" Schwalbe Right Run
- 25" Schwalbe Camber tires, white
- 25" Solid tires
- 26" Schwalbe Marathon Plus
- 26" Schwalbe Right Run
- 26" Schwalbe Camber tires, white
- 26" Solid tires
- 28" Schwalbe Camber tires, white

- | | | |
|---|---------|-------------------------------|
| <input type="checkbox"/> Handrim aluminium, short (standard) | +HPL100 | <input type="checkbox"/> Wide |
| <input type="checkbox"/> Handrim stainless steel, short | +HPL200 | <input type="checkbox"/> Wide |
| <input type="checkbox"/> Handrim with silicone cover, short | +HPL300 | <input type="checkbox"/> Wide |
| <input type="checkbox"/> Handrim Tetra Curve (24", 25"), short | +HPL400 | <input type="checkbox"/> Wide |
| <input type="checkbox"/> Handrim Tetra Curve L (24", 25", 26"), short | +HPL415 | <input type="checkbox"/> Wide |
| <input type="checkbox"/> Handrim titanium, short (24") | +HPL500 | <input type="checkbox"/> Wide |
| <input type="checkbox"/> Handrim Woody, short (24", 25", 26") | +HPL750 | <input type="checkbox"/> Wide |
| <input type="checkbox"/> Handrim Quadro, short (24", 25", 26") | +HPL850 | <input type="checkbox"/> Wide |
| <input type="checkbox"/> Handrim Gekko, short (24", 25", 26") | +HPL950 | <input type="checkbox"/> Wide |
| <input type="checkbox"/> Handrim Gekko S, short (24", 25", 26") | +HPL970 | <input type="checkbox"/> Wide |
-
- Spoke guards, transparant (pair)
 - Spoke guards, black (pair)

<input type="checkbox"/> Seat cushion TNS Comfort Curve, stretch cover (Polyether contour)
<input type="checkbox"/> Seat cushion TNS Comfort Curve, waterproof cover (Polyether contour)
<input type="checkbox"/> Other type or brand cushion, price on request
Brand & type: - product code:
<input type="checkbox"/> RAL colour (std. gloss), RAL No. colour name:
<input type="checkbox"/> Matt finish (6% gloss)
<input type="checkbox"/> Glitter finish
<input type="checkbox"/> Polished powdercoat (chrome look)
<input type="checkbox"/> Special coated parts, price on request

If you have any special requests for the build of the wheelchair or about options, please contact us for more information, at wheelchairtechnology@tnsrijen.nl.