

Order form

TNS Proval 2022

Dealer:

Advisor:

Client:

Adres:

Phone:

Framenumber:

Order date:

Date of fitting:

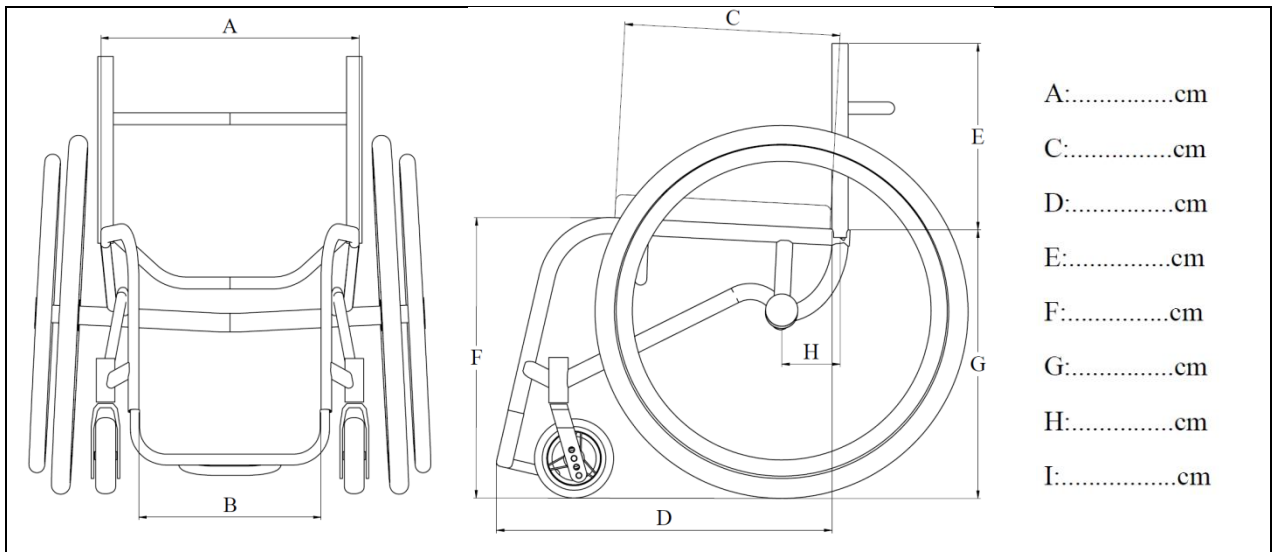

- Proval custom made ADL (boxframe)
- Proval custom made Sport (boxframe)
- Basketball type CBB PRO2136 Hockey type CH PRO2137 Dancing type CD
- Tennis type CT PRO2138 Badminton type CB PRO2135 other sorts.....
- Heavy Duty frame 100-125 kg
- A; Seat width (with removable sideguards effective seat width will be +1cm)
- Tapered seatframe

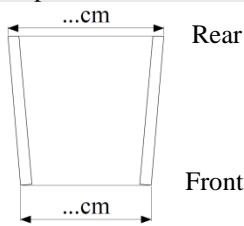

- Partially tapered seatframe

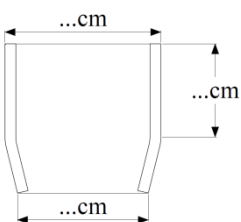

- B; Std tapered front frame (U-frame). Space between front frame tubes is 9cm smaller than seat width

- Custom tapered front frame (20cm space in between frame tubes at minimum)

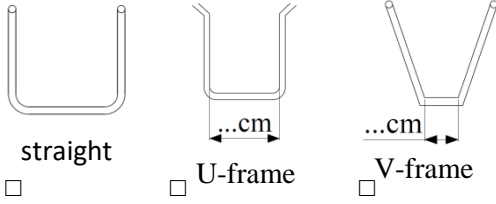

- C; Seat depth
- Ergonomic seat

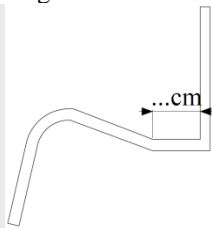

- Frame extension from seat sling forward

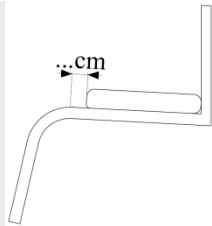

- D; Frame length: front backrest to front footrest
- E; Backrest height

- Backrest foldable/angle adjustable
- Backrest welded
- Backrest-angle 90 degrees with the floor
 - Backrest <90 degrees (forward angle)
 - Backrest >90 degrees (backward angle)

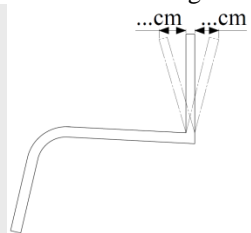

- Adjustable lateral backrest tubes with double fixation
- Lumbar shaped backrest tubes

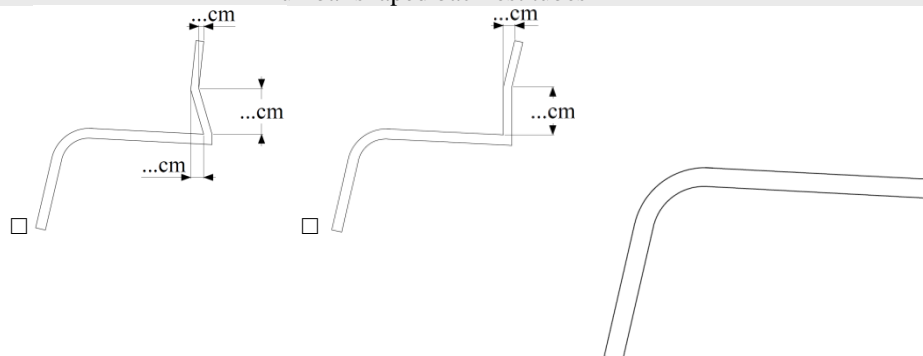

<input type="checkbox"/> Custom depth backrest stabilizer (std 6 cm)		
<input type="checkbox"/> Backrest lockable <input type="checkbox"/> Backrest lockable with pulling cord <input type="checkbox"/> Tension adjustable backrest upholstery (std.): <input type="checkbox"/> Middle backrest upholstery breathable fabric (black) <input type="checkbox"/> Red <input type="checkbox"/> Black <input type="checkbox"/> Fabric provided by customer <input type="checkbox"/> Middle backrest upholstery in nylon <input type="checkbox"/> Red <input type="checkbox"/> Blue <input type="checkbox"/> Yellow <input type="checkbox"/> Green <input type="checkbox"/> White <input type="checkbox"/> Black <input type="checkbox"/> Side backrest upholstery in nylon <input type="checkbox"/> Red <input type="checkbox"/> Blue <input type="checkbox"/> Yellow <input type="checkbox"/> Green <input type="checkbox"/> White <input type="checkbox"/> Black <input type="checkbox"/> Tension adjustable backrest upholstery and cushion cover leather <input type="checkbox"/> Backrest upholstery special (necessary with adjustable tapered backrest) <input type="checkbox"/> Tension adjustable backrest upholstery in leather <input type="checkbox"/> Side backrest fabric in leather <input type="checkbox"/> Seat depth adjustable (backrest on clamp block)		
<input type="checkbox"/> F; Frame height front <input type="checkbox"/> G; Frame height rear <input type="checkbox"/> H; Centre of gravity (C.O.G.) <input type="checkbox"/> Adjustable C.O.G. <input type="checkbox"/> Second rear axle. C.O.G.: cm (handbike axle) <input type="checkbox"/> Camber ... degrees (0 – 20 degrees) <input type="checkbox"/> I; Footrest, height and angle adjustable (aluminium plate 22x12cm) <input type="checkbox"/> I; Footrest, welded (footrest tube)		

Caster type Activator (large barings)

Caster type Proval (small barings)

Space below footrest (front and rear)

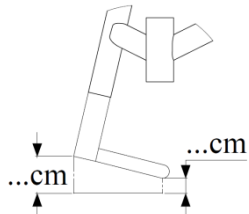

Total maximum width*

**as an indication (depending on seat width, camber and wheelspace)*

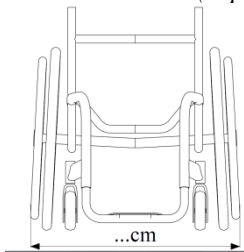

Wheelspace standard 2,5cm or cm

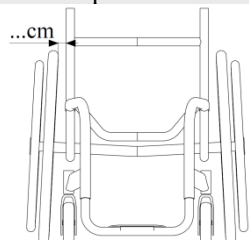

Length caster. Front caster to front footrest



Caster position backwards

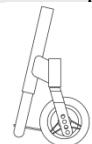

Caster position forwards



- Urgent order, netto price (not always available)
- Aluminium seat plate welded on frame
- Scissor brakes (not available on all models)
- Scissor brakes on a sports wheelchair (not available on all models)
- Scissor brakes, compact
- Push/pull brakes
- Push/pull brakes on a sports wheelchair
- Push/pull brakes, single handed
- Push/pull brakes, compact

left / right operated

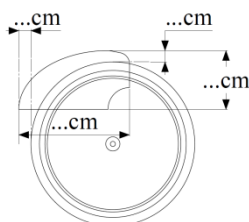
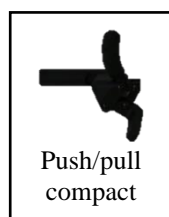
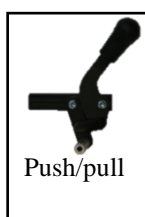
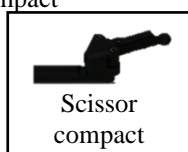

! Removable sideguards add +1cm in effective seat width !

- Aluminium removable sideguards with fender
- Aluminium removable sideguards, std. height (21cm)
- Aluminium removable sideguards, custom measurements
- Aluminium welded sideguards, with fender
- Aluminium welded sideguards, custom measurements
- Carbon sideguards bolt on (only with welded backrest)
- Carbon sideguards with fender, bolt on (only with welded backrest)
- Carbon sideguards, removable
- Carbon sideguards with fender, removable
- Rubber strip on sideguards
- Welded tube on sideguard (inside)
- Welded tube on sideguard (outside)
- Inside sideguard lined with foam, 1cm
- Inside sideguard lined with foam, 2cm
- Height adjustable/removable armrest (only with aluminium sideguards)
- Kid std. (26cm) long (36cm)
- Armrest padding straight (36 cm)
- Armrest height adjustable type E.T., short
- Armrest height adjustable type E.T., long

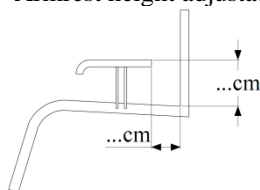

- Frame protectors, black
- Anti-tip Quick Release. left
- Anti-tip quick release. right
- Anti-tip sportstyle, single, removable

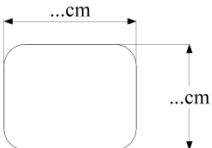
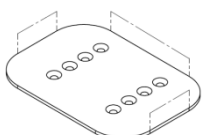
- Anti-tip sportstyle, single, welded
 - Anti-tip sportstyle, double, welded
 - Anti-tip, swing away, left right
 - Calf strap
 - Feet strapping
- 
- Feet strapping PVC
 - Feet strapping A2J cm.
 - Footplate ABS
 - Footplate aluminium
 - Anti slip on footplate
 - Custom size footplate
- 
- Raised edges on footplate (please add drawing)
- 
- Seperate foldable footrests, including extra stabilizer
 - Swing away footrest (one piece)
 - Left, including extra stabilizer
 - Right, including extra stabilizer
 - Backwards
 - Welded tube under footplate (wear-plate)
 - Extra front frame stabilizer
 - Defence bumper (sport)
 - Full wing (not suited for Quad Rugby)
 - Push handles foldable
 - Heavy Duty height adjustable/removable push handles. Height from the floor.....cm
 - Push handles on backrest stabilizer (combine with welded or lockable backrest)
 - Height adjustable/removable push handles. Height from the floorcm
 - Push handles bold on, model TNS
 - Hemiplegic dance handle, left. Height from the floorcm
 - Hemiplegic dance handle, right. Height from the floorcm
 - Walking stick tray, stainless steel quick release mount
 - Standard swing away leg rest, 90 degrees, left
 - Standard swing away leg rest, 90 degrees, right
 - Standard swing away leg rest, 75 degrees, left
 - Standard swing away leg rest, 75 degrees, right
 - Leg rest socket welded in frame, left (leg rest not included)
 - Leg rest socket welded in frame, right (leg rest not included)
 - Comfort swing away leg rest, left. Including plastic calf plate
 - Comfort swing away leg rest, left. Including cushioned calf plate

- Comfort swing away leg rest, right. Including plastic calf plate
- Comfort swing away leg rest, right. Including cushioned calf plate
- Safety strapping (nylon and Velcro), cm
- Strapping A2J 2D Small STR402 Large
- Strapping A2J 3D Small STR502 Large
- Strapping WH line
- Taxi fixation points, rear and front, welded (ISO 7176-19 compliant)
- Aluminium welded wear-plate on back axle
- Wheelchair tray, custom size (please add drawing)
- Wheelchair tray, mounting, welded in frame
- Frog Leg suspension front fork
- Mono-fork, 1,5" wide (only 4" or 5" wheels)
- One Arm Drive 24" / 25" / 26" left / light (not possible with HD frame)
- Custom One Arm Drive handrim (please add drawing)
- Preparation for powered wheels (Alber/Decon) 12.7mm

- 3" LED wheels
- 3" Sport (hard)
- 3" Frogleg extra wide
- 4" LED wheels
- 4" Sport / daily (hard)
- 4" Soft rol
- 4" Star wheels
- 5" LED wheels
- 5" Daily (hard)
- 5" Soft rol
- 5" Star wheels
- 6" Poly
- 6" Frogleg extra wide
- Dust caps

- 20" Rear wheels
- 22" Rear wheels
- 24" Rear wheels
 - Black Silver Red Blue (matching forks)
- 24" Sports wheels
- 24" Spinergy LX, 12 spokes (black*)
- 24" Spinergy SLX, 24 spokes (black*)
- 24" Spinergy LX with Flexrim, 12 spokes (black*)
- 24" Spinergy SLX with Flexrim, 24 spokes (black*)
- 24" Off Road wheels, aluminium handrim, incl. ATB tires eff. 24"/25"/26"
- 25" Rear wheels
 - black Silver Red Blue (matching forks)
- 25" Sports wheels
- 25" X-Core wheels (3-spoke carbon)
- 25" Spinergy LX 12 spokes (black*)
- 25" Spinergy SLX 24 spokes (black*)
- 25" Spinergy LX with Flexrim, 12 spokes (black*)
- 25" Spinergy SLX with Flexrim, 24 spokes (black*)
- 26" Sports wheels
- 26" Spinergy LX, 12 spokes (black*)
- 26" Spinergy SLX, 24 spokes (black*)

- 26" Spinergy LX with Flexrim, 12 spokes (black*)
- 26" Spinergy SLX with Flexrim, 24 spokes (black*)
- 28" Sports wheels

- 24" Schwalbe Marathon Plus
- 24" Schwalbe Right Run
- 24" Schwalbe Camber tires, white
- 24" Solid tires
- 25" Schwalbe Marathon Plus
- 25" Schwalbe Right Run
- 25" Schwalbe Camber tires, white
- 25" Solid tires
- 26" Schwalbe Marathon Plus
- 26" Schwalbe Right Run
- 26" Schwalbe Camber tires, white
- 26" Solid tires
- 28" Schwalbe Camber tires, white

- | | | |
|---|---------|-------------------------------|
| <input type="checkbox"/> Handrim aluminium, short (standard) | +HPL100 | <input type="checkbox"/> Wide |
| <input type="checkbox"/> Handrim stainless steel, short | +HPL200 | <input type="checkbox"/> Wide |
| <input type="checkbox"/> Handrim with silicone cover, short | +HPL300 | <input type="checkbox"/> Wide |
| <input type="checkbox"/> Handrim Tetra Curve (24", 25"), short | +HPL400 | <input type="checkbox"/> Wide |
| <input type="checkbox"/> Handrim Tetra Curve L (24", 25", 26"), short | +HPL415 | <input type="checkbox"/> Wide |
| <input type="checkbox"/> Handrim titanium, short | +HPL500 | <input type="checkbox"/> Wide |
| <input type="checkbox"/> Handrim dual grip (black), short | +HPL600 | <input type="checkbox"/> Wide |
| <input type="checkbox"/> Handrim dual grip (silver), short | +HPL650 | <input type="checkbox"/> Wide |
| <input type="checkbox"/> Handrim Woody, short | +HPL750 | <input type="checkbox"/> Wide |
| <input type="checkbox"/> Handrim Quadro, short | +HPL850 | <input type="checkbox"/> Wide |
| <input type="checkbox"/> Handrim Gekko, short | +HPL950 | <input type="checkbox"/> Wide |
| <input type="checkbox"/> Handrim Gekko S, short | +HPL970 | <input type="checkbox"/> Wide |
|
 | | |
| <input type="checkbox"/> Spoke guards, transparent (pair) | | |
| <input type="checkbox"/> Spoke guards, black (pair) | | |

- Seat cushion TNS Comfort Curve, stretch cover (Polyether contour)
 - Seat cushion TNS Comfort Curve, waterproof cover (Polyether contour)
 - Other type or brand cushion, price on request
- Brand & type: - product code:

-
- RAL colour (std. gloss), RAL No. colour name:
 - Matt finish (6% gloss)
 - Glitter finish
 - Polished powdercoat (chrome look)
 - Special coated parts, price on request

If you have any special requests for the build of the wheelchair or about options, please contact us for more information, at wheelchairtechnology@tnsrijen.nl.