

Order form

TNS rsX 2022

Dealer:	Advisor:	Client:
Adres:		
Phone:		
Frumenter:	Order date:	Date of fitting:

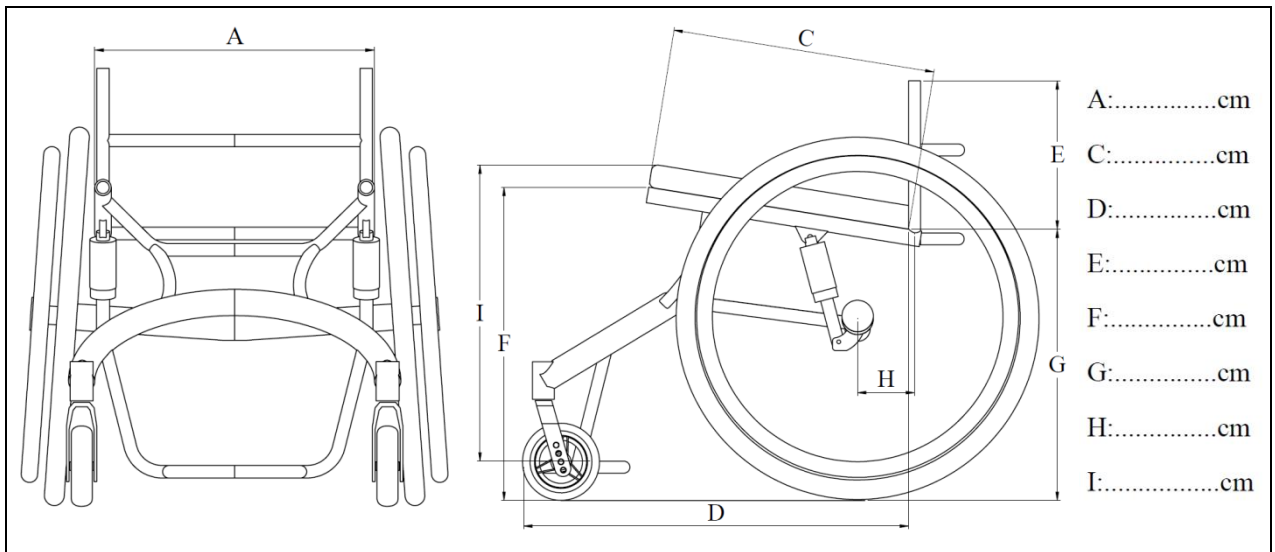

- rsX custom made suspension ADL
- rsX custom made rigid ADL
- Heavy Duty frame 100-125 kg
- A; Seat width (with removable sideguards effective seat width will be +1cm)
- Castor width (hart to hart) 41cm 46,5cm 52cm 56,5cm

Partially tapered seatframe

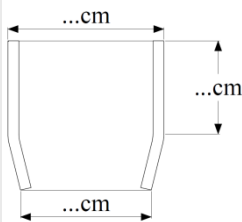

Front frame (optional, 20cm space in between frame tubes at minimum)

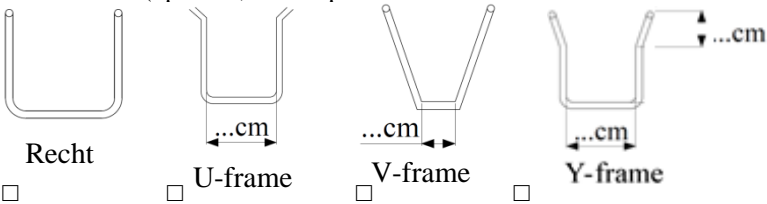

C; Seat depth

Ergonomic seat

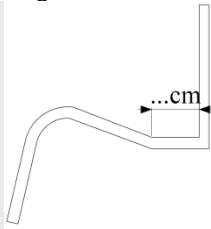

Frame extension from seat sling forward

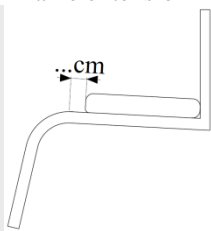

D; Frame length: front backrest to front castors

E; Backrest height

Backrest foldable/angle adjustable

Backrest welded

Backrest-angle 90 degrees with the floor

Backrest <90 degrees (forward angle)

Backrest >90 degrees (backward angle)

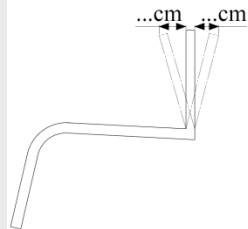

Adjustable lateral backrest tubes with double fixation

Lumbar shaped backrest tubes

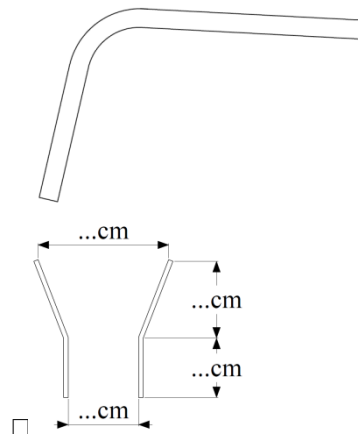
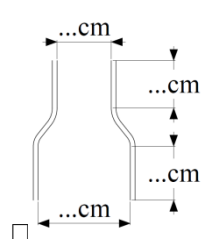
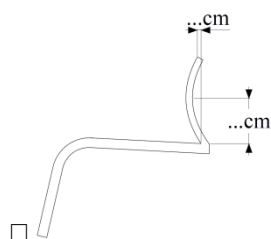
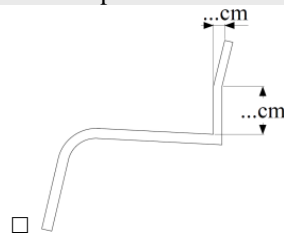
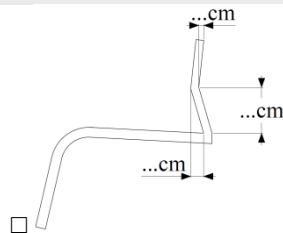

- Custom depth backrest stabilizer (std 6 cm)

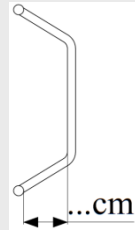

- Backrest lockable
- Backrest lockable with pulling cord
- Tension adjustable backrest upholstery (std.):
 - Middle backrest upholstery breathable fabric (black)
 - Red Black Fabric provided by customer
 - Middle backrest upholstery in nylon
 - Red Blue Yellow Green White Black
 - Side backrest upholstery in nylon
 - Red Blue Yellow Green White Black
- Tension adjustable backrest upholstery and cushion cover leather
- Backrest upholstery special (necessary with adjustable tapered backrest)
- Tension adjustable backrest upholstery in leather
- Side backrest fabric in leather
- Seat depth adjustable (backrest on clamp block)

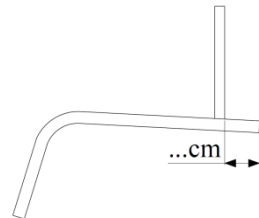

- F; Frame height front
- G; Frame height rear
- H; Centre of gravity (C.O.G.)
- Second rear axle. C.O.G.: cm (handbike axle)
- Camber ... degrees (0 – 6 degrees)
- I; Footrest, welded (footrest tube)
- I; Footrest, height and angle adjustable (aluminium plate 22x12cm)
- Space below footrest (front and rear)

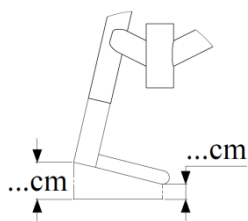

- Total maximum width*

**as an indication (depending on seat width, camber and wheelspace)*

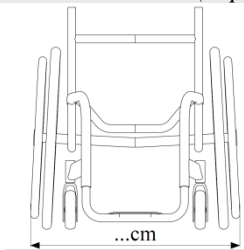

- Wheelspace standard 2,5cm or cm

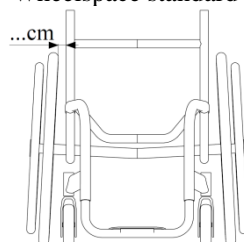

- Urgent order, netto price (not always available)
- Aluminium seat plate welded on frame
- Scissor brakes (not available on all models)
- Scissor brakes, Colours style
- Push/pull brakes
- Push/pull brakes, compact

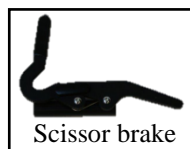

Scissor brake

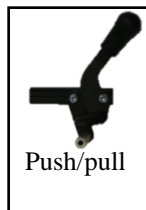

Push/pull

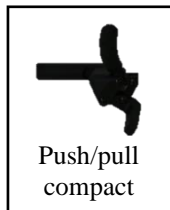

Push/pull compact

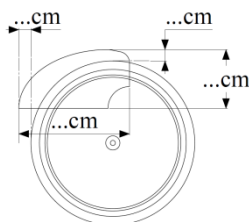

! Removable sideguards add +1cm in effective seat width !

- Aluminium removable sideguards with fender
- Aluminium removable sideguards, std. height (21cm)
- Aluminium removable sideguards, custom measurements
- Aluminium welded sideguards, with fender
- Aluminium welded sideguards, custom measurements
- Carbon sideguards bolt on (only with welded backrest)
- Carbon sideguards with fender, bolt on (only with welded backrest)
- Carbon sideguards, removable
- Carbon sideguards with fender, removable
- Rubber strip on sideguards

- Welded tube on sideguard (inside)
- Welded tube on sideguard (outside)
- Inside sideguard lined with foam, 1cm
- Inside sideguard lined with foam, 2cm
- Height adjustable/removable armrest (only with aluminium sideguards)
- Kid std. (26cm) long (36cm)
- Armrest padding straight (36 cm)
- Armrest height adjustable type E.T., short
- Armrest height adjustable type E.T., long

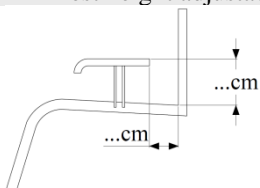

- Frame protectors, black
- Anti-tip Quick Release. left
- Anti-tip Quick Release. right
- Anti-tip, swing away, left right
- Calf strap
- Feet strapping

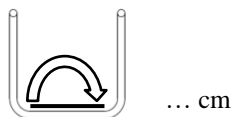

- Feet strapping PVC
- Feet strapping A2J cm.
- Footplate ABS
- Footplate aluminium
- Anti slip on footplate
- Custom size footplate



- Raised edges on footplate (please add drawing)

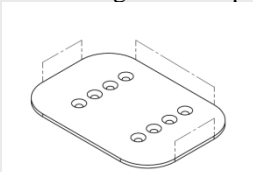

- Separate foldable footrests, including extra stabilizer
- Swing away footrest (one piece)
 - Left, including extra stabilizer
 - Right, including extra stabilizer
 - Backwards
- Extra front frame stabilizer

- Push handles foldable
- Heavy Duty height adjustable/removable push handles. Height from the floor.....cm
- Push handles on backrest stabilizer (combine with welded or lockable backrest)
- Height adjustable/removable push handles. Height from the floorcm
- Push handles bold on, model TNS
- Walking stick tray, stainless steel quick release mount
- Standard swing away leg rest, 90 degrees, left
- Standard swing away leg rest, 90 degrees, right
- Standard swing away leg rest, 75 degrees, left
- Standard swing away leg rest, 75 degrees, right
- Leg rest socket welded in frame, left (leg rest not included)
- Leg rest socket welded in frame, right (leg rest not included)
- Comfort swing away leg rest, left. Including plastic calf plate
- Comfort swing away leg rest, left. Including cushioned calf plate
- Comfort swing away leg rest, right. Including plastic calf plate
- Comfort swing away leg rest, right. Including cushioned calf plate
- Safety strapping (nylon and Velcro), cm
- Strapping A2J 2D Small STR402 Large
- Strapping A2J 3D Small STR502 Large
- Taxi fixation points, rear and front, welded (ISO 7176-19 compliant)
- Aluminium welded wear-plate on back axle
- Wheelchair tray, custom size (please add drawing)
- Wheelchair tray, mounting, welded in frame
- Frog Leg suspension front fork
- Mono-fork, 1,5" wide (only 4" or 5" wheels)
- One Arm Drive 24" / 25" / 26" left / light (not possible with HD frame)
- Custom One Arm Drive handrim (please add drawing)
- Preparation for powered wheels (Alber/Decon) 12.7mm

- 3" LED wheels
- 3" Sport (hard)
- 3" Frogleg extra wide
- 4" LED wheels
- 4" Sport / daily (hard)
- 4" Soft rol
- 4" Star wheels
- 5" LED wheels
- 5" Daily (hard)
- 5" Soft rol
- 5" Star wheels
- 6" Poly
- 6" Frogleg extra wide
- Dust caps

- 20" Rear wheels
- 22" Rear wheels
- 24" Rear wheels

- Black Silver Red Blue (matching forks)
- 24" Sports wheels
- 24" Spinergy LX, 12 spokes (black*)
- 24" Spinergy SLX, 24 spokes (black*)
- 24" Spinergy LX with Flexrim, 12 spokes (black*)
- 24" Spinergy SLX with Flexrim, 24 spokes (black*)
- 24" Off Road wheels, aluminium handrim, incl. ATB tires eff. 24"/25"/26"
- 25" Rear wheels
 - black Silver Red Blue (also forks)
- 25" Sports wheels
- 25" X-Core wheels (3-spoke carbon)
- 25" Spinergy LX 12 spokes (black*)
- 25" Spinergy SLX 24 spokes (black*)
- 25" Spinergy LX with Flexrim, 12 spokes (black*)
- 25" Spinergy SLX with Flexrim, 24 spokes (black*)
- 26" Sports wheels
- 26" Spinergy LX, 12 spokes (black*)
- 26" Spinergy SLX, 24 spokes (black*)
- 26" Spinergy LX with Flexrim, 12 spokes (black*)
- 26" Spinergy SLX with Flexrim, 24 spokes (black*)
- 28" Sports wheels

- 24" Schwalbe Marathon Plus
- 24" Schwalbe Right Run
- 24" Schwalbe Camber tires, white
- 24" Solid tires
- 25" Schwalbe Marathon Plus
- 25" Schwalbe Right Run
- 25" Schwalbe Camber tires, white
- 25" Solid tires
- 26" Schwalbe Marathon Plus
- 26" Schwalbe Right Run
- 26" Schwalbe Camber tires, white
- 26" Solid tires
- 28" Schwalbe Camber tires, white

<input type="checkbox"/> Handrim aluminium, short (standard)	+HPL100	<input type="checkbox"/> Wide
<input type="checkbox"/> Handrim stainless steel, short	+HPL200	<input type="checkbox"/> Wide
<input type="checkbox"/> Handrim with silicone cover, short	+HPL300	<input type="checkbox"/> Wide
<input type="checkbox"/> Handrim Tetra Curve (24", 25"), short	+HPL400	<input type="checkbox"/> Wide
<input type="checkbox"/> Handrim Tetra Curve L (24", 25", 26"), short	+HPL415	<input type="checkbox"/> Wide
<input type="checkbox"/> Handrim titanium, short	+HPL500	<input type="checkbox"/> Wide
<input type="checkbox"/> Handrim dual grip (black), short	+HPL600	<input type="checkbox"/> Wide
<input type="checkbox"/> Handrim dual grip (silver), short	+HPL650	<input type="checkbox"/> Wide
<input type="checkbox"/> Handrim Woody, short	+HPL750	<input type="checkbox"/> Wide
<input type="checkbox"/> Handrim Quadro, short	+HPL850	<input type="checkbox"/> Wide
<input type="checkbox"/> Handrim Gekko, short	+HPL950	<input type="checkbox"/> Wide
<input type="checkbox"/> Handrim Gekko S, short	+HPL970	<input type="checkbox"/> Wide
<input type="checkbox"/> Spoke guards, transparant (pair)		
<input type="checkbox"/> Spoke guards, black (pair)		

<input type="checkbox"/> Seat cushion TNS Comfort Curve, stretch cover (Polyether contour) <input type="checkbox"/> Seat cushion TNS Comfort Curve, waterproof cover (Polyether contour) <input type="checkbox"/> Other type or brand cushion, price on request Brand & type: - product code:
<input type="checkbox"/> RAL colour (std. gloss): Top frame RAL No. colour name: Rear axle RAL No. colour name:
<input type="checkbox"/> Matt finish (6% gloss) <input type="checkbox"/> Glitter finish <input type="checkbox"/> Polished powdercoat (chrome look) <input type="checkbox"/> Special coated parts, price on request

If you have any special requests for the build of the wheelchair or about options, please contact us for more information, at wheelchairtechnology@tnsrijen.nl.